

# Installation instructions for PZ4AL-02141-00

## Toyota Yaris

Under Run Protective Shield engine bay and transmission case



Model Year: 2011

Vehicle Code: NSP130L-CHXNKW

Part Number: PZ4AL- 02141- 00



Weight: 7.9 Kg



Installation Time: 40 min

Part number: PZ4AL-02141-00

**A**

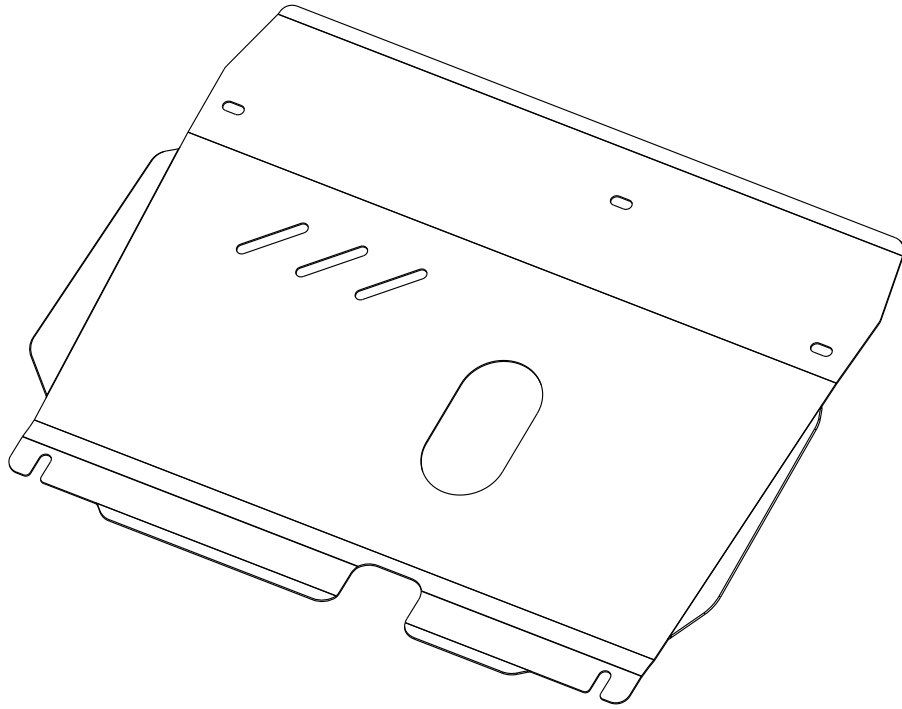

PZ4AL-02141-60

**B1**

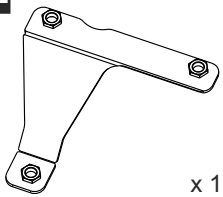

x 1

**B2**

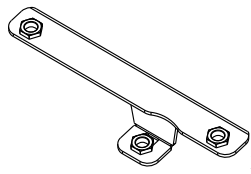

x 1

**B3**

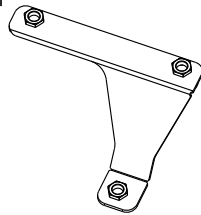

x 1

**C**

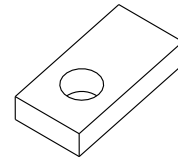

x 2

**D**



11 x M 8x20

**E**



11 x Ø 10

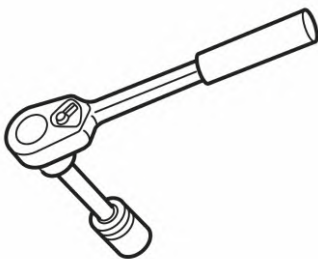

Part number:  
PZ4AL-02141-00

Issue:  
0

Date:  
06/12/11

Page:  
2/8

1

FWD

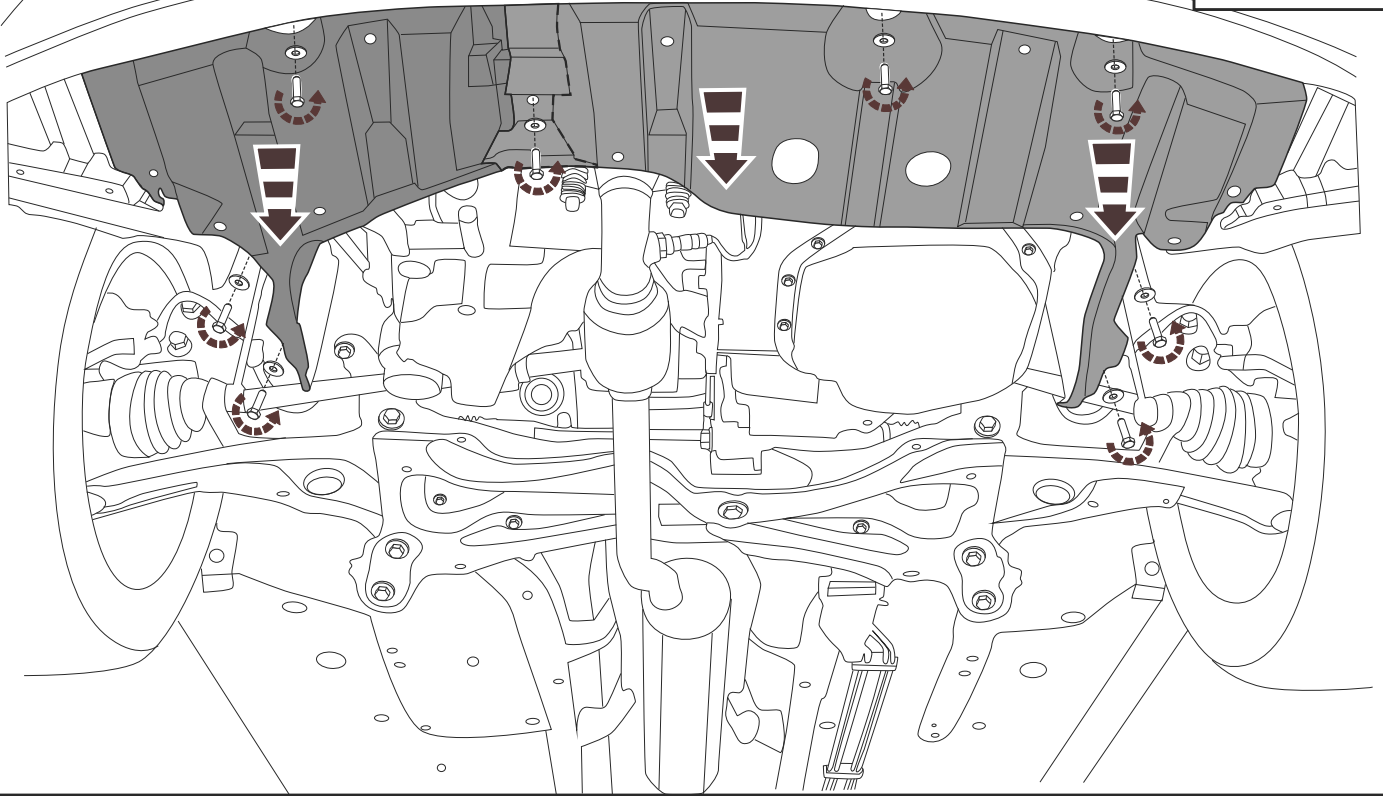
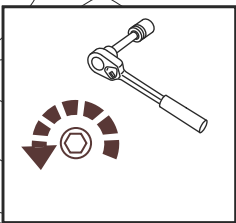

2

FWD

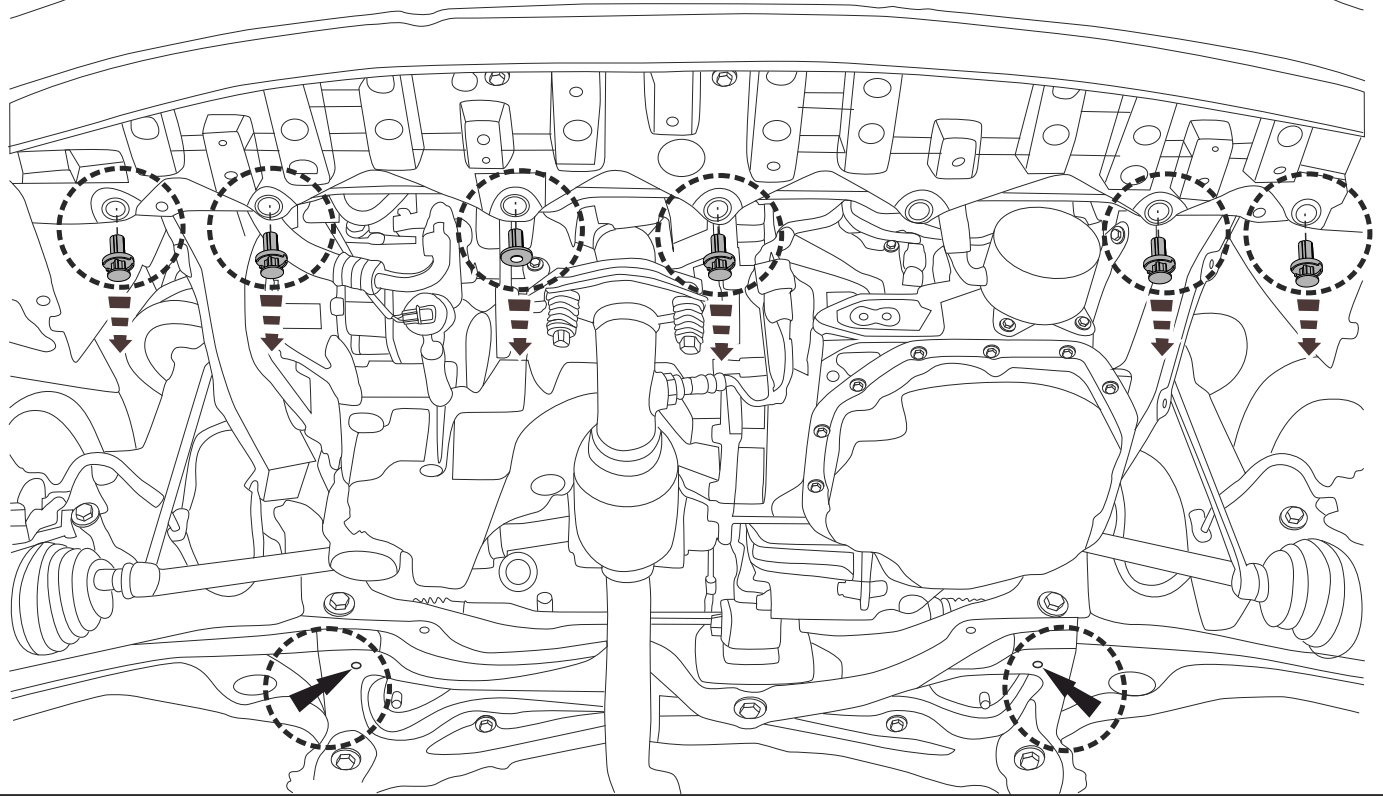

3

1

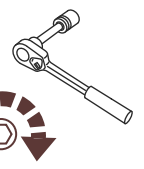

M8 = 24 Nm

FWD ↑

B1

B2

B3

E

D

1

1

1

1

1

1

E

D

E

D



C

E

D

4

FWD ↑

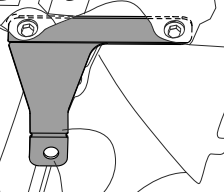
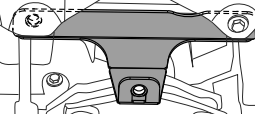
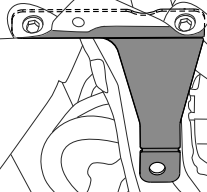

5

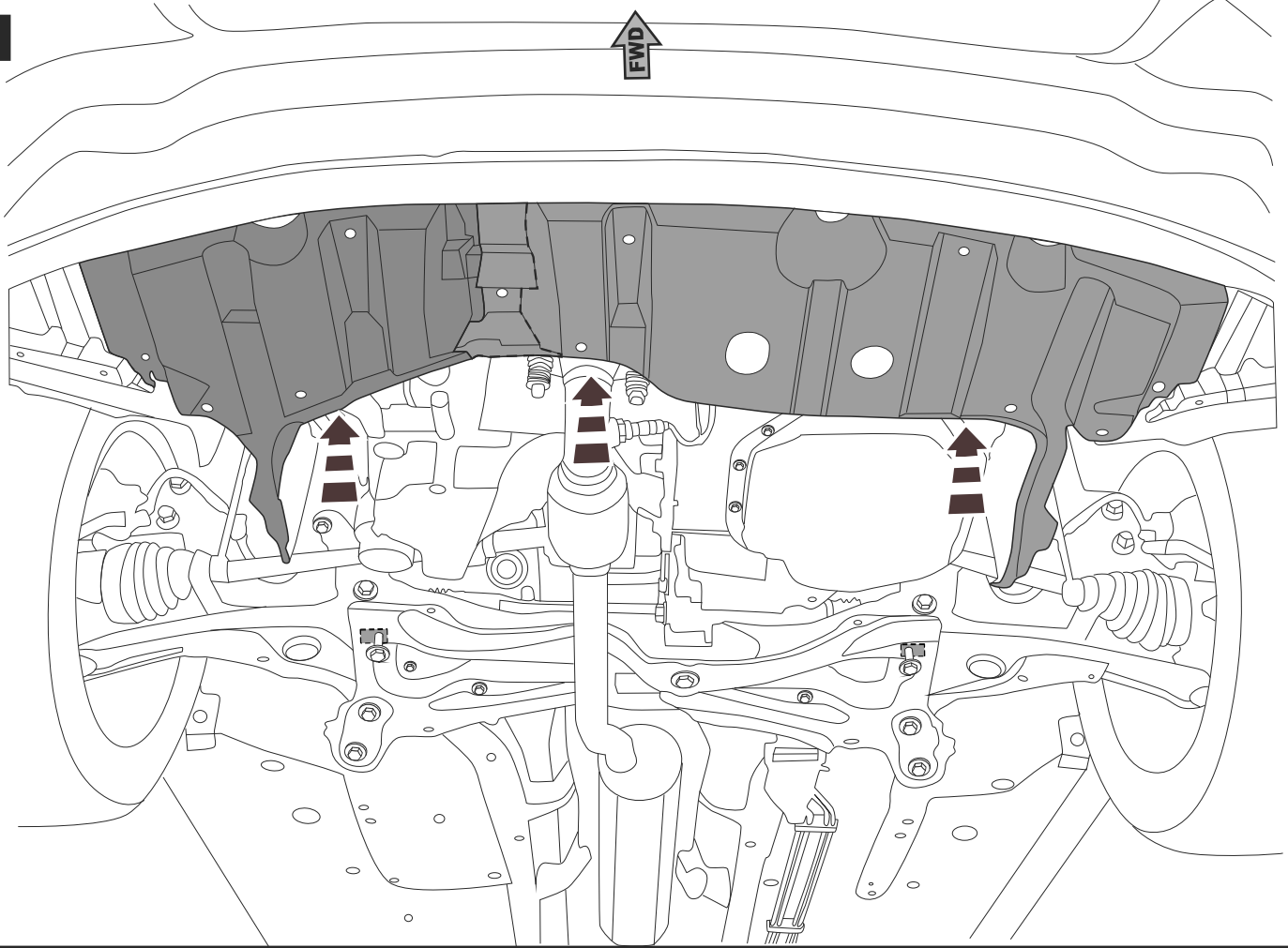

6

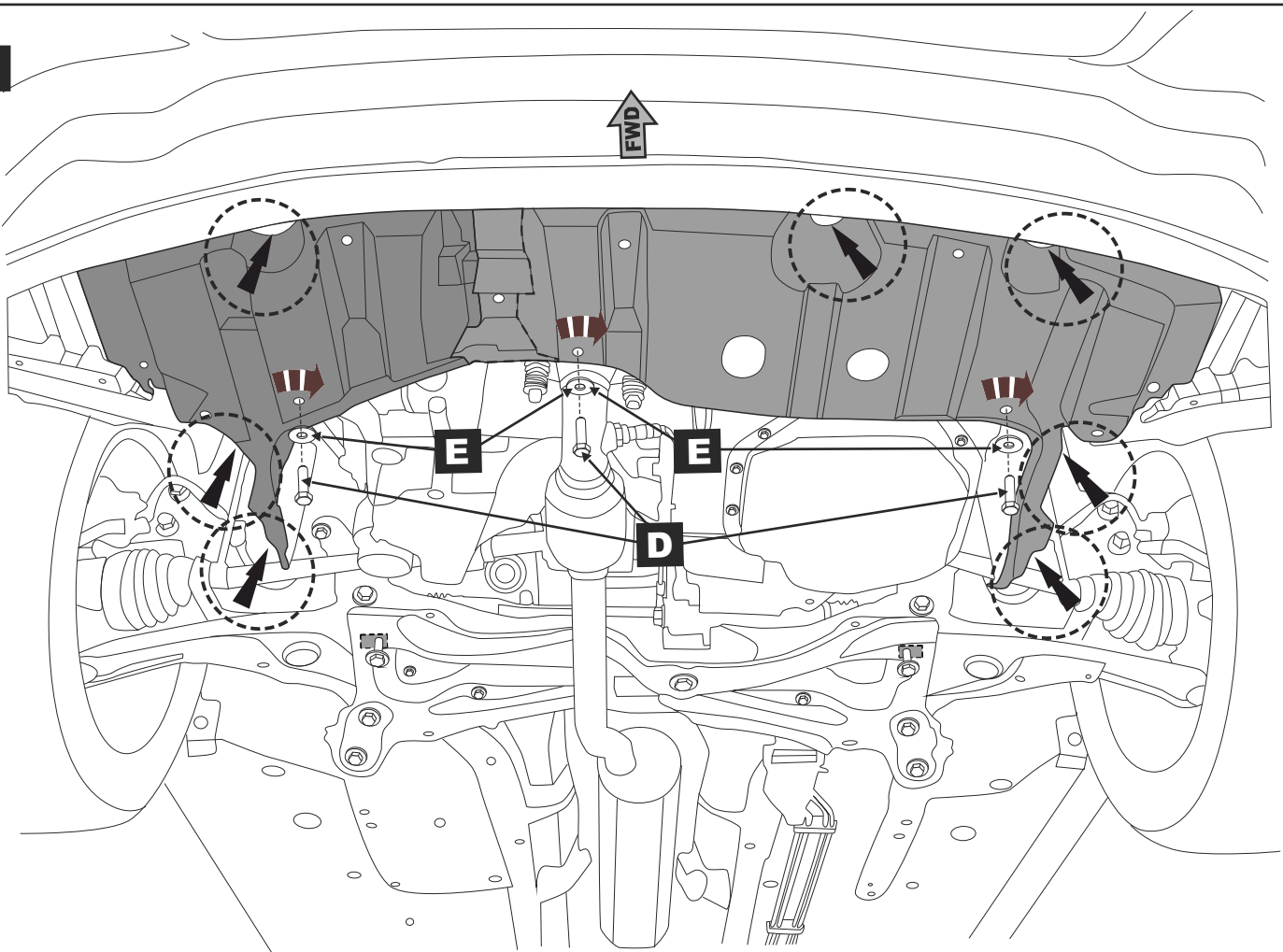



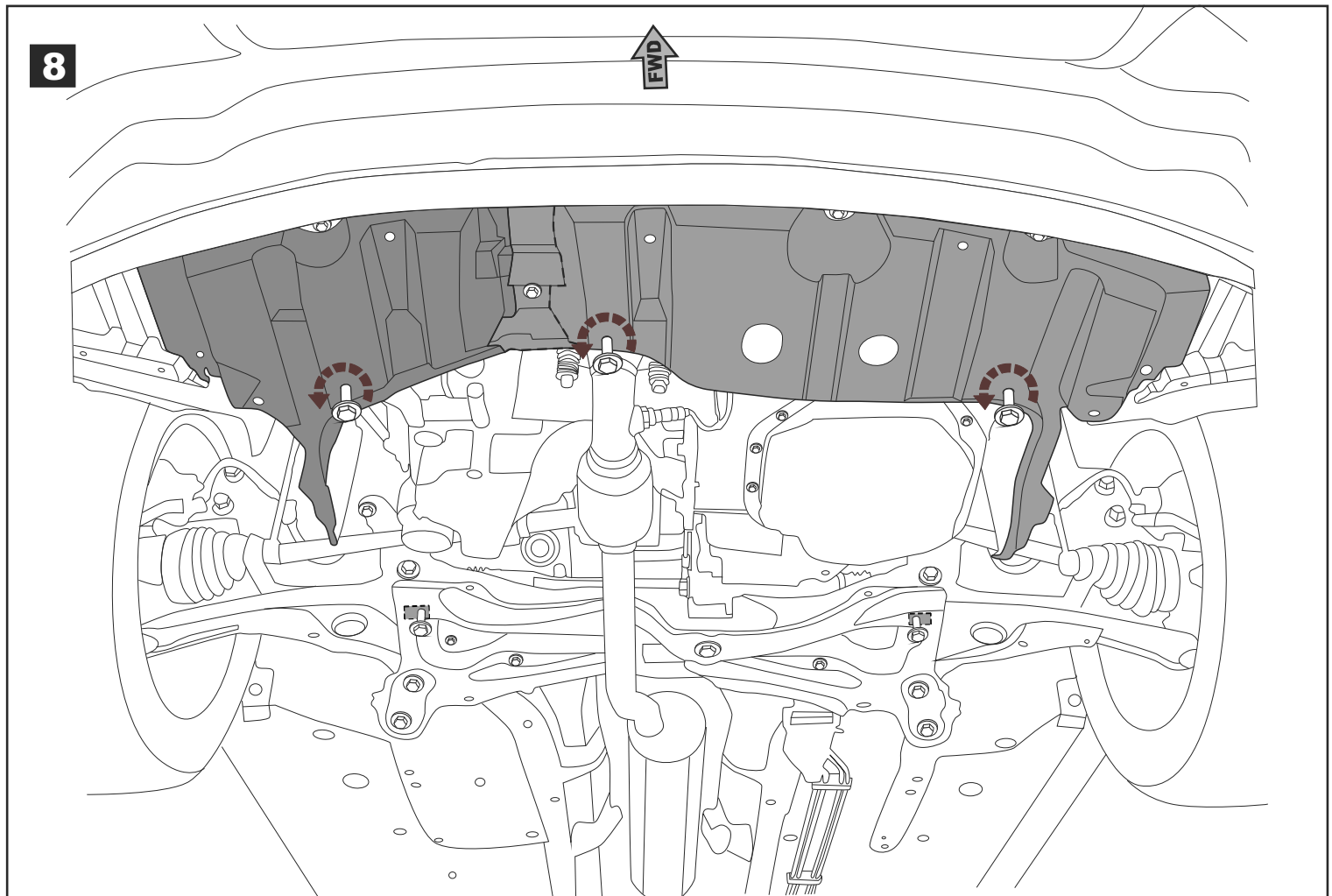
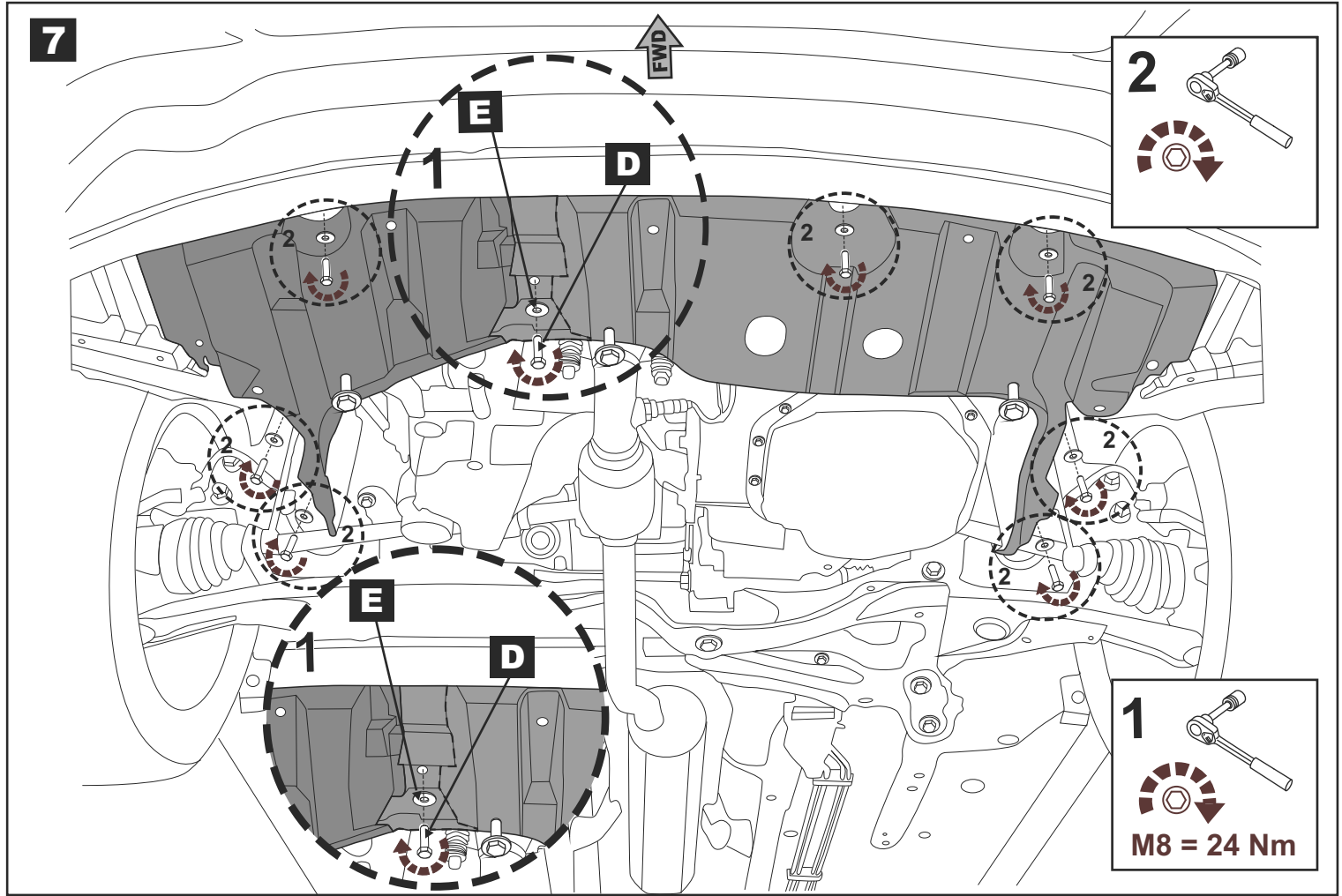

9

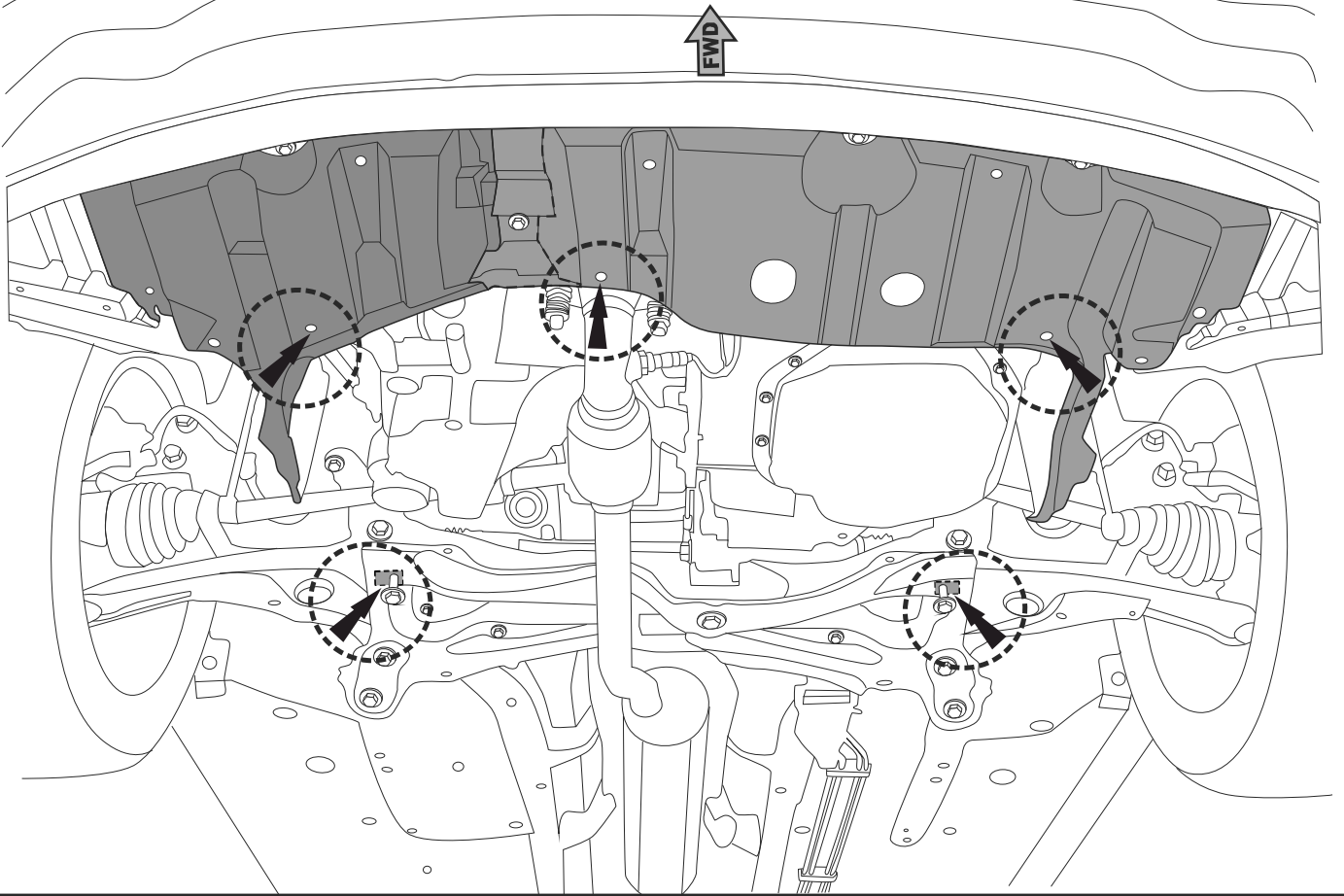

10

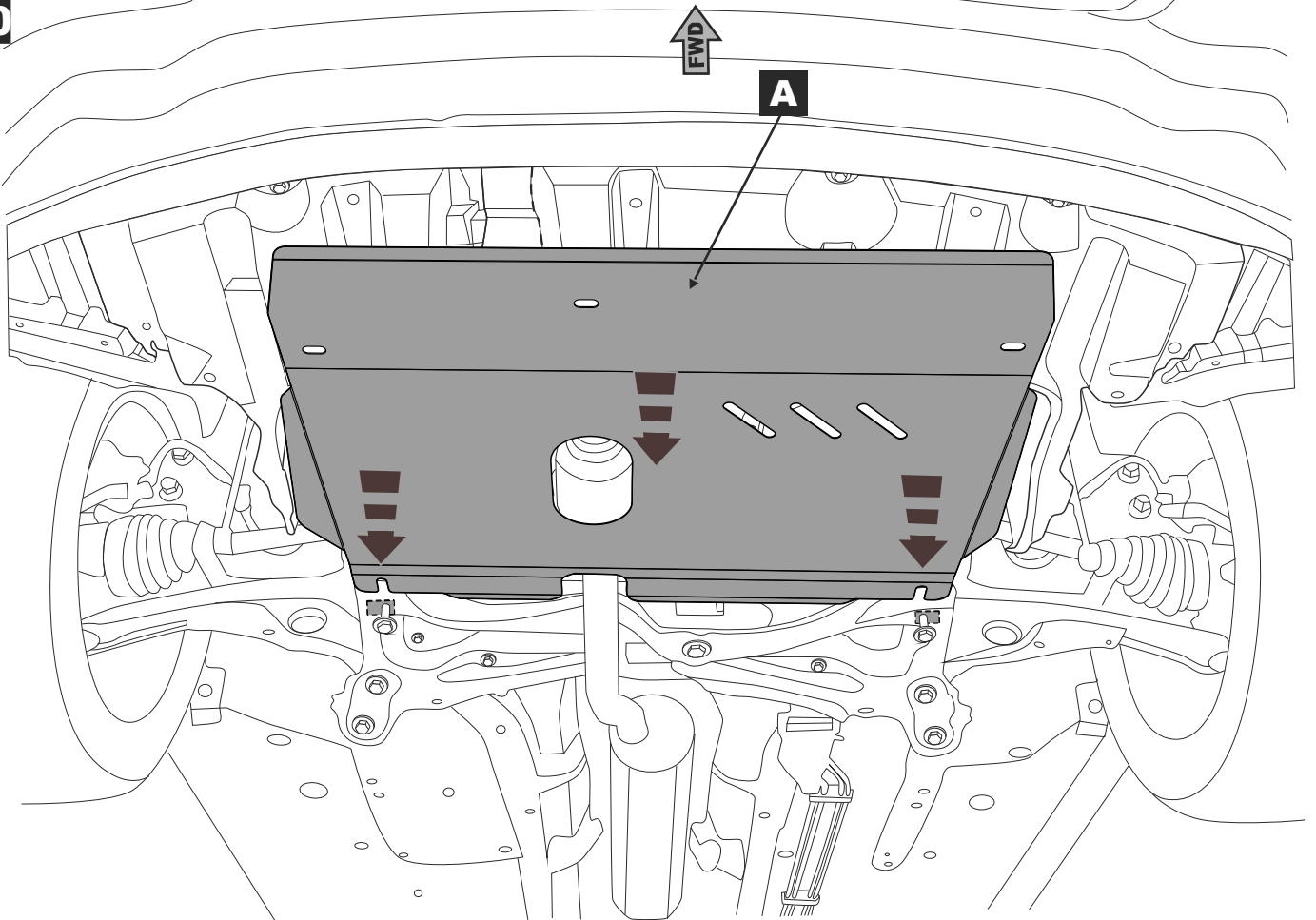

11

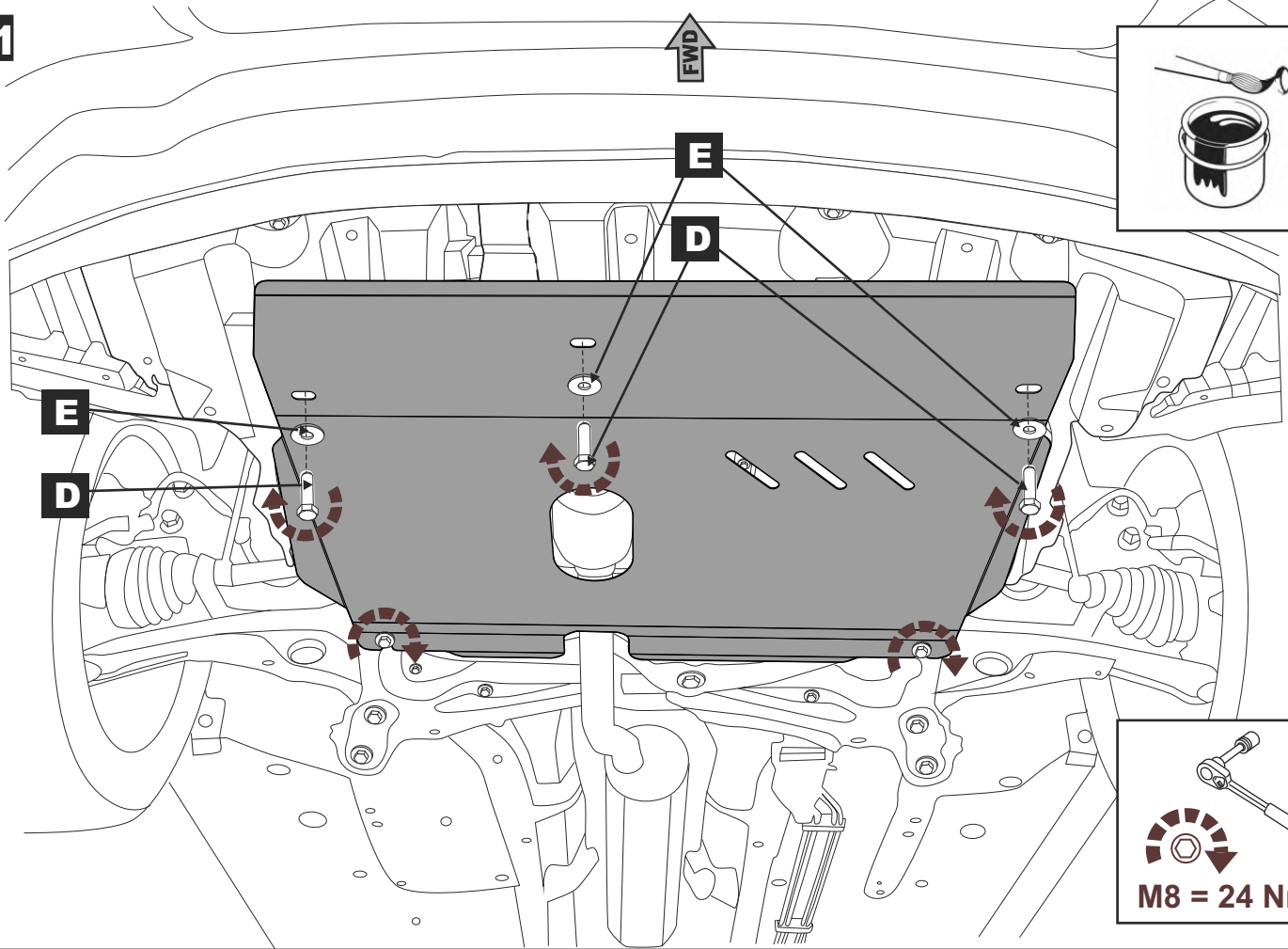

12

